

BETA

Better visibility, better protection

Beta welding helmets provide exceptional protection for the eyes and face. Designed for professional welders and certified to EN175 B for welding, cutting and grinding processes, Beta welding helmet range includes either passive or auto-darkening filters.

All Beta models feature the same lightweight but strong shell construction, a comfort headband, GapView flip lens function and magnifying lens frame. When combined with a Kemppi PAPR system, Beta FA models offer TH2 respiratory protection for your lungs.

-
- Protection for welding, grinding and cutting
 - Flip-lens with GapView stage position
 - Extra protection to face and neck
 - ADF and passive lens models
 - Comfort headband
 - Magnifying lens frame
-



Welding helmets



Beta 60P/60A/90P/90A/90X

Lightweight welding and grinding shields. Flip-up passive or automatic welding lens models, large clear view visor, GapView setting, comfort headband. (Page 26)

Welding respirator systems



Beta 90 SFA/90 XFA

TH2 rated PAPR packages, featuring solutions for both particle and gas filtration. Suitable for welding, grinding and inspection operations. Automatic welding lens options. (Page 27)



Beta 90 SFA/XFA Airline

Welder respirators for connection to a supplied breathing air source. Suitable for welding, grinding and inspection operations. Automatic welding lens options. (Page 27)

Comfort, value and protection
for the eyes, face and lungs



BETA WELDING HELMETS

Designed for professional welders and certified to EN175 B for welding, grinding and cutting processes, Beta welding helmet range includes five models equipped with either passive or automatic filters. All Beta models feature the same lightweight but strong shell construction, a comfort headband, GapView flip lens function and magnifying lens frame.

Model options and features

- Beta 60P/60A/90P/90A/90X
- For welding, tacking, cutting, grinding and inspection
- Passive or ADF welding lens options
- Beta 90X features XA 47 LiFE+ Color ADF including shades 14 and 15
- EN 175 B and AS/NZS 1337.1
- Deeper protection for facial sides
- Comfort headband
- Magnifying lens option
- See page 46 for models specification



Beta models feature a range of automatic welding filters, plus optional magnifying lenses.





BETA RESPIRATORY MODELS

Beta FA respirators provide cool and clean breathing air, from either a PFU 210e battery powered filter unit offering optimal freedom of movement around the workspace, or a supplied breathing air solution where the air flow is regulated from the RSA 230. Although movement is controlled to a local area, supplied air solutions suit applications where welding and shielding gases may build up displacing the breathing air. Beta FA models are certified with a maximum inward leakage level of 2 % and when connected to the PFU 210e filter unit, offer the option of combined particle and gas filtration.

Model options and features

- Beta 90 SFA/XFA
- For welding, tacking, cutting, grinding, inspection
- Battery powered PAPR or airline supplied models
- XFA model features LiFE+ Color ADF technology including shades 14 and 15
- EN 175 B, AS/NZS 1337.1, EN 12941 TH2 and AS/NZS 1716
- Particle and gas filter options
- Fast charging PAPR battery packs
- Leather belt and metal buckle
- Comfort headband
- Magnifying lens option



XA 47 features LiFE+ Color technology and shade adjustment 5, 8, 9-13 and 14, 15.



ADF lens SA 47 featuring shade adjustment 9-13, plus grinding mode.



AUTO-DARKENING WELDING FILTERS

Digitally controlled protection for your eyes

Welding shields fitted with auto-darkening filters (ADF) protect your eyes from the intense light of the welding arc and UV/IR radiation. The ADF technology is based on liquid crystals that have the ability to switch their state when exposed to bright light, automatically switching from clear to dark instantly when you strike the arc and back to clear again when the arc is extinguished. The lens shade and its sensitivity to light is set by you according to the welding task and your personal needs.

Kemppi's ADF selection offers five models with different shade ranges and features. Please see the compatibility table.

LiFE+ Color ADF technology enables greater clarity of vision and improved work accuracy, which reduces user eye strain and fatigue. LiFE+ Color lenses improve color recognition and optical quality.

Remote-RC feature is included to Gamma welding helmets fitted with an ADF lens, making adjustment of the ADF extremely easy whilst wearing the helmet. The remote control buttons are protected from impact and conveniently placed, making adjustment simple without taking the helmet off. Gamma ADF parameters are marked by color LEDs and can be clearly seen and recognized from inside the helmet, ideal for parameter adjustment when moving between tasks.



Before



During



After



Gamma ADF remote control is designed for operation whilst wearing the helmet. The orange silicone rubber remote buttons are located inside the helmet shell wall, adding protection from knocks and abrasions. The wearer can adjust the ADF settings and view the changes on the large ADF panel interface, plus switch on and off the LED work lights in Gamma GTH3 XFA model.

ADF SPECIFICATION

and compatibility

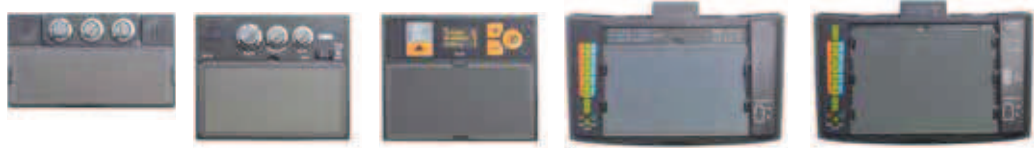

ADF model	SA 35	SA 47	XA 47	SA 60	XA 74
Ordering code	SP9873061	SP9873062	SP9873063	SP012422	SP012421
Inner protection plate item number	SP012951	SP012952	SP012952	SP012425	SP012424
CE classification	1/1/1/2	1/1/1/2	1/1/1/2	1/1/1/2	1/1/1/2
LiFE+ Color	No	No	Yes	Yes	Yes
View size	96 x 35	97 x 47	97 x 47	102 x 60	102 x 74
Filter dimension	110 x 61	110 x 90	110 x 90	Customized	Customized
Size of inner protection plate	108 x 37	104 x 54	104 x 54	106.5 x 65.5	106.5 x 75
Arc sensor	2	2	2	2	2
Shade range	4/9-13	4/9-13	4/9-13 CUTTING 5 14-15	4/5,8/9-13 CUTTING 5	4/5,8/9-13 CUTTING 5 14-15
Shade level of POWER OFF state	4	4	6	4	6
Power ON/OFF	Fully automatic	Fully automatic	Fully automatic	Fully automatic	Fully automatic
Shade control	Internal	Internal	Internal, digital display	External	External
Switching time (ms)	0.1	0.1	0.1	0.1	0.1
Grinding function	No	Yes	Yes	No	No
Low battery indicator	No	Yes	Yes	Yes	Yes
Low amperage TIG rated (A)	5	5	5	5	5
Power supply	Solar Cell, 2 x CR2032, replaceable	Solar Cell, non-replaceable	Solar Cell, 1 x CR2450, replaceable	Solar Cell, 1 x CR2450, replaceable	Solar Cell, 1 x CR2450, replaceable PAPR battery
Certification	CE, ANSI, CSA	CE, ANSI, CSA, AS/NZS	CE, ANSI, CSA, AS/NZS	CE, ANSI, CSA, AS/NZS	CE, ANSI, CSA, AS/NZS

ADF compatibility

SA 35	Beta 60A
SA 47	Beta 90A / Beta 90 SFA / Delta 90 SFA
XA 47	Beta 90X / Beta 90 XFA / Delta+ 90 XFA
SA 60	Gamma 100A / Gamma GTH3 SFA
XA 74	Gamma GTH3 XFA

BETA 60P



Beta 60P

9873040

Beta 60P welding helmet with shade 11 passive welding filter.

Spare parts and accessories

Protection plate (60 x 110), 10 pcs	SP9873252
Passive welding filter (shade 11, size 60 x 110)	9873191
Safety plate (90 x 110 x 1.5), 10 pcs	SP9873254
Filter retaining spring	3149840
Magnifying lens holder	SP011159
Headband	4306370
Sweatband, 2 pcs	SP9873018
Hatch set	4301040

Welding filters

Shade 8	9873161
Shade 9	9873171
Shade 10	9873181
Shade 11	9873191
Shade 12	9873202
Shade 13	9873211

Magnifying lenses

Diopter 1.0 (51 x 108 mm)	9873260
Diopter 1.5 (51 x 108 mm)	9873261
Diopter 2.0 (51 x 108 mm)	9873262
Diopter 2.5 (51 x 108 mm)	9873263

SP9873252



9873191



3149840



SP9873254

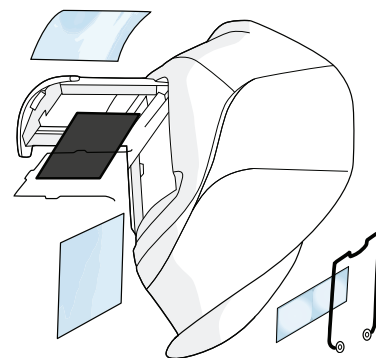

SP9873018

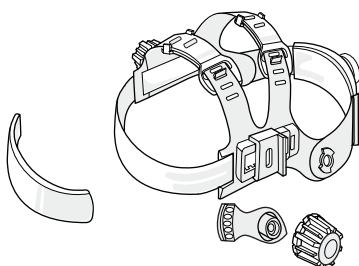

4306370



9873161

9873171

9873181

9873191

9873202

9873211



9873260

9873261

9873262

9873263

SP011159

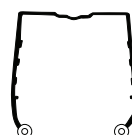

4301040

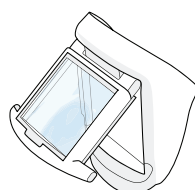

ORDERING CODES

BETA 60A



Beta 60A

9873041

Beta 60A welding helmet with auto-darkening welding filter SA 35.

Spare parts and accessories

Protection plate (60 x 110), 10 pcs	SP9873252
ADF welding filter SA 35 (shades 9-13, size 60 x 110)	SP9873061
Inner protection plate for SA 35 (108 x 37), 5 pcs	SP012951
Safety plate (90 x 110 x 1.5), 10 pcs	SP9873254
Filter retaining spring	3149840
Magnifying lens holder	SP011159
Headband	4306370
Sweatband, 2 pcs	SP9873018
Hatch set	4301040

Magnifying lenses

Diopter 1.0 (51 x 108 mm)	9873260
Diopter 1.5 (51 x 108 mm)	9873261
Diopter 2.0 (51 x 108 mm)	9873262
Diopter 2.5 (51 x 108 mm)	9873263

SP9873252



SP9873061



SP012951



3149840

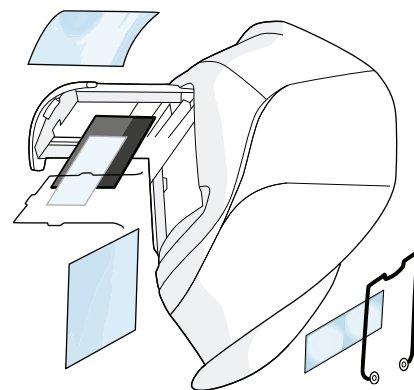

SP9873018

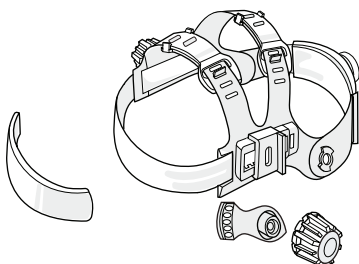

4306370

4301040



SP9873254



9873260
9873261
9873262
9873263

SP011159

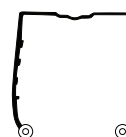

BETA 90P



Beta 90P

9873045

Beta 90P welding helmet with shade 11 passive welding filter.

Spare parts and accessories

Protection plate, 10 pcs	SP9873253
Passive welding filter (shade 11, size 90 x 110)	9873244
Safety plate (90 x 110 x 1.5), 10 pcs	SP9873254
Filter retaining spring	3149850
Magnifying lens holder	SP011159
Headband	4306370
Sweatband, 2 pcs	SP9873018
Hatch set	4301050

Welding filters

Shade 8	9873241
Shade 9	9873242
Shade 10	9873243
Shade 11	9873244
Shade 12	9873245
Shade 13	9873246

Magnifying lenses

Diopter 1.0 (51 x 108 mm)	9873260
Diopter 1.5 (51 x 108 mm)	9873261
Diopter 2.0 (51 x 108 mm)	9873262
Diopter 2.5 (51 x 108 mm)	9873263

SP9873253



9873244



3149850

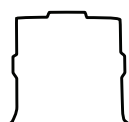

9873241
9873242
9873243
9873244
9873245
9873246

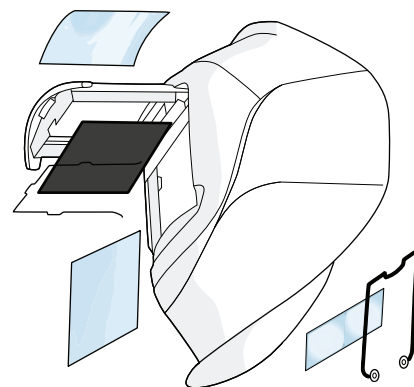

SP9873018

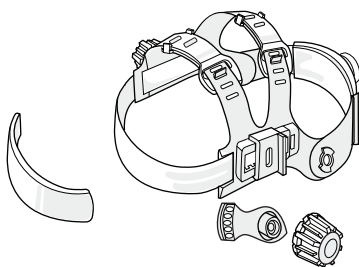

4306370

4301050

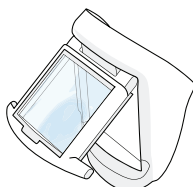

SP9873254



9873260
9873261
9873262
9873263

SP011159

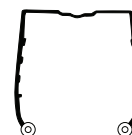

BETA 90A



Beta 90A

9873046

Beta 90A welding helmet with auto-darkening welding filter SA 47.

Spare parts and accessories

Protection plate , 10 pcs	SP9873253
ADF welding filter SA 47 (shades 9-13, size 90 x 110)	SP9873062
Inner protection plate for SA 47 / XA 47 (104 x 54), 5 pcs	SP012952
Safety plate (90 x 110 x 1.5), 10 pcs	SP9873254
Filter retaining spring	3149850
Magnifying lens holder	SP011159
Headband	4306370
Sweatband, 2 pcs	SP9873018
Hatch set	4301050

Magnifying lenses

Diopter 1.0 (51 x 108 mm)	9873260
Diopter 1.5 (51 x 108 mm)	9873261
Diopter 2.0 (51 x 108 mm)	9873262
Diopter 2.5 (51 x 108 mm)	9873263

SP9873253



SP9873062



SP012952

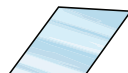

3149850

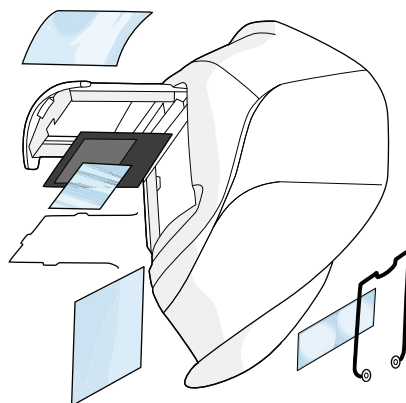
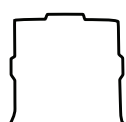

SP9873018

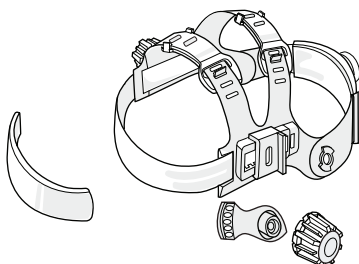

4306370

4301050



SP9873254



9873260
9873261
9873262
9873263

SP011159

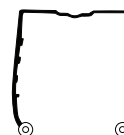

BETA 90X



Beta 90X

9873047

Beta 90X welding helmet with auto-darkening welding filter XA 47.

Spare parts and accessories

Protection plate, 10 pcs	SP9873253
ADF welding filter XA 47 (shades 9-15, size 90 x 110)	SP9873063
Inner protection plate for SA 47 / XA 47 (104 x 54), 5 pcs	SP012952
Safety plate (90 x 110 x 1.5), 10 pcs	SP9873254
Filter retaining spring	3149850
Magnifying lens holder	SP011159
Headband	4306370
Sweatband, 2 pcs	SP9873018
Hatch set	4301050

Magnifying lenses

Diopter 1.0 (51 x 108 mm)	9873260
Diopter 1.5 (51 x 108 mm)	9873261
Diopter 2.0 (51 x 108 mm)	9873262
Diopter 2.5 (51 x 108 mm)	9873263

SP9873253



SP9873063



SP012952

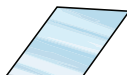

3149850

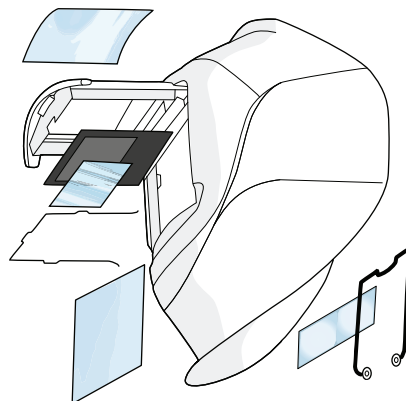
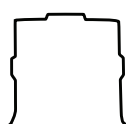

SP9873018

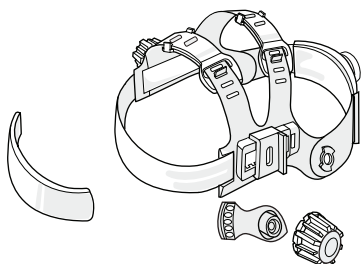

4306370

4301050



SP9873254



9873260
9873261
9873262
9873263

SP011159

